



# SUMMIT SERIES

Vertical multi-stage pumps







*VMS 1 – 5 Series Assembly Procedures*

WATER SUPPLY • INDUSTRIAL BOOSTING • INDUSTRIAL LIQUID TRANSFER • WATER TREATMENT • IRRIGATION

**BIANCO** **NXT**

pumps

**Summit Series VMS pump assembly tools**

	<b>Tool name</b>	<b>Tool specification</b>	<b>Application</b>	<b>Where to use it</b>	<b>Remarks</b>	<b>Tool picture</b>
1	Rubber hammer		All models	Knock the seal base to make it tighter if necessary		
2	Double offset ring spanners	10mm	M6	For nuts #22 and Bolts #42 & #80		
		14mm	M8			
		17mm	M10			
		19mm	M12			
		22mm	M14	For nuts #6 & #74		
24mm	M16					
3	Allen keys	2.5mm	For mechanical seal screw VMS 1-20	Mechanical Seal retaining screws Loosening and tightening of the shaft coupling		
		3mm	For mechanical seal screw VMS 32-90			
		5mm	M6			
		6mm	M8			
		8mm	M10			
4	Phillips screwdriver		M4	Coupling guard retaining screws		
			M5			
5	Open spanner	12mm Across Face	NJK12 (VMS 1-5)	For mechanical seal.		
		16mm Across Face	NJK16 (VMS 10-20)			
6	Jig	Assembly Jig #1	VMS 1-5	Shaft support.		
		Assembly Jig #2	VMS 10-20	Shaft support.		

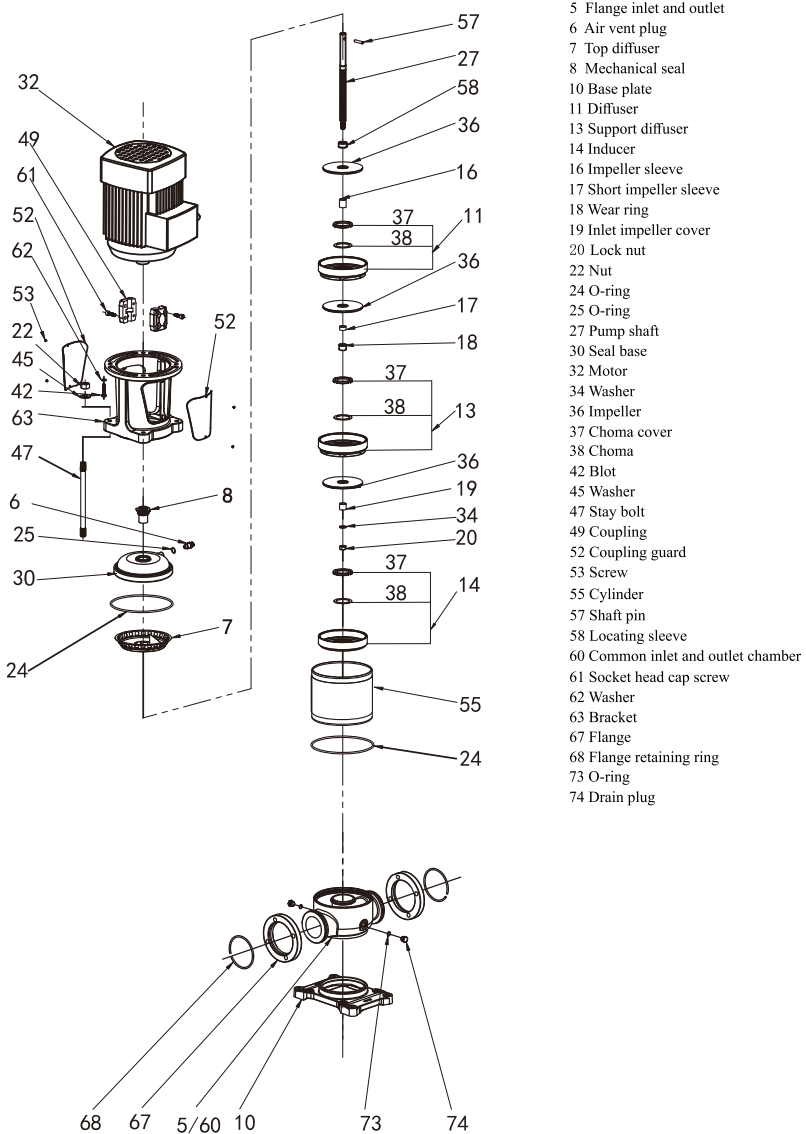

**Exploded view VMS Series 1 - 5**

## SUMMIT VMS Series 1 - 5 components list

No.	Name	Photo	No.	Name	Photo
5	Inlet & outlet chamber		17	Short impeller sleeve	
6	Air vent		18	Wear ring	
7	Top diffuser		19	Inlet impeller cover	
8	Mechanical seal		20	Lock nut	
10	Base plate for flange connection		22	Nut	
11	Diffuser		24	O ring	
13	Support diffuser		25	O ring	
14	Inducer		27	Shaft	
16	Impeller sleeve		30	Seal base	

SUMMIT VMS Series 1 - 5 components list

No.	Name	Photo	No.	Name	Photo
32	Motor		57	Shaft pin	
34 45 62	Washer		58	Locating sleeve	
36	Impeller		61	Socket Head Cap Screw	
42	Bolt		63	Bracket	
47	Staybolt		67	Flange	
49	Coupling		68	Retaining ring	
52	Coupling guard		73	O-ring	
53	Screw		74	Drain plug	
55	Cylinder				



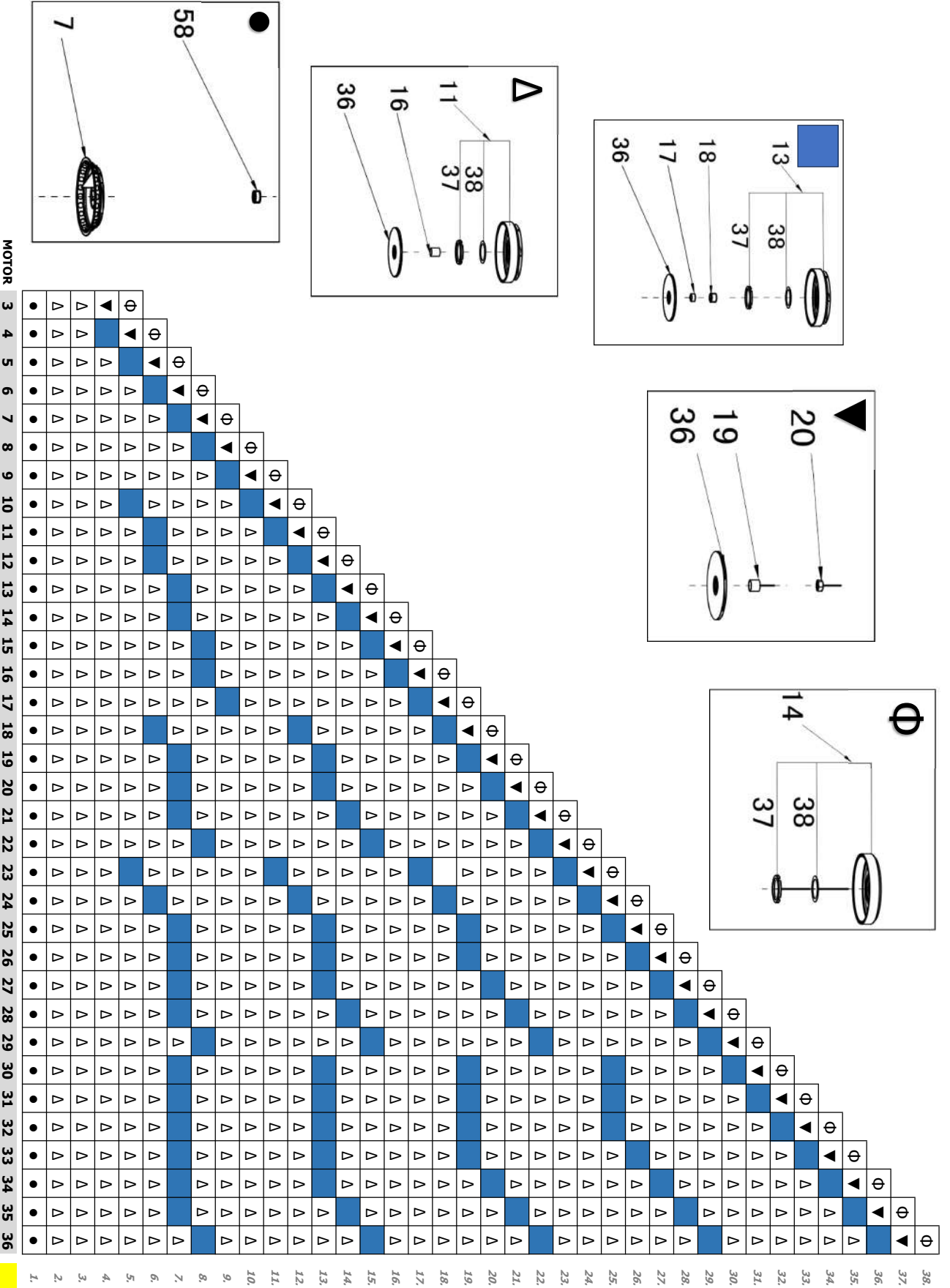

# VMS 1 ~ 5 Component Order



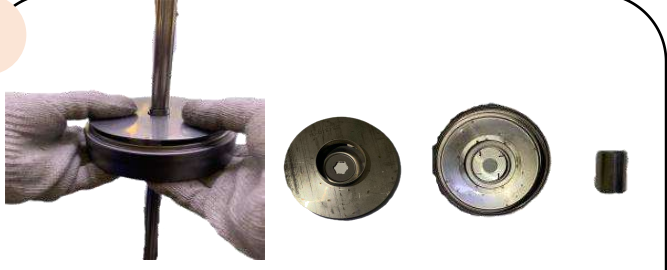

## Stack assembly

- 

1 Fit the shaft (#27) into the shaft holding jig. Press the locating sleeve (#58) onto the shaft, and down onto the locating circlip.
- 

2 Install the impeller (#36), diffuser (#11) and impeller sleeve (#16) in sequence. The impeller (#36) should rotate freely
- 

3 Repeat step 2 according to the Pump Stack distribution diagram on the previous page
- 

4 The sleeve in the support diffuser (#13) is a combination of a short impeller sleeve (#17) and wear ring (#18). Note that the wear ring (#18) is in full contact with the supporting parts in support diffuser (#13)
- 

5 After placing the last impeller, install the inlet impeller cover (#19) and tighten the nut (#20)
- 

6 Tighten the nut (#20) with a torque wrench  $45 \pm 5$  Nm
- 

7 Note that the top diffuser (#7) and the inducer (#14) need to be inserted when assembling the pump body. The top diffuser (#7) is placed on top (left side), and the inducer (#14) is placed on the bottom (right side)

# Pump Body Assembly Part A

1



Place the base plate (#10)

2



Install the inlet / outlet chamber (#5) on base plate (#10).  
**Note that the direction of inlet / outlet chamber and the arrow direction of the shaft are the direction of the water flow**

3



Spray vegetable oil on to the inlet / outlet chamber (#10) and O-ring (#24). Stretch and place the O-ring into the inlet / outlet chamber (#10) recess

4



Place O-rings (#25 & #73) onto the drainage plug (#74) as shown. Install the drainage nut (#74) into the inlet / outlet chamber (#60) and tighten

5



Fit and press the Cylinder (#55) firmly into place.  
**Take care not to damage the O-ring.**

6



Fit the stack by lowering it into the inlet / outlet chamber (#60)

7



Install the four stay bolts (#47). Do not expose thread from the base plate more than 2 mm

8



Install spring (#56) into seal base (#30). Edges of spring must point downward as shown for all models. Place O-ring (#24) into recessed area of seal base with some oil.

9



Lower and fully press into seal base (#30) onto the cylinder (#55) taking care not to break O-ring (#24)

10



Seat the bracket (#63). Fit washers (#45) and nuts (#22) on the four stay bolts (#47) and tighten them.  
Torque requirement  $50 \pm 5\text{Nm}$ .



## Pump Body Assembly Part B

**11**



Place O-ring (#25) on air vent nut (#6). Install the air vent nut (#6) and tighten it

**12**



Place the mechanical seal (#8) onto the shaft (#27) and tighten it.  
Torque:  $30 \pm 2$  Nm.

**13**



Tighten the three locating grub screws at the top of the mech seal (#8)

**14**



Lift up the pump shaft (#27) and plug in the mechanical seal spacer 'gasket'.

**15**



Use a lifting device to lift the motor (#32) and place it on the bracket (#63). Tighten motor retaining bolts

**16**



Install the shaft pin (#57)

**17**



**CORRECT**

Top View

Gap between coupling

Keyway

Keyway

**CORRECT**      **NOT CORRECT**

Ensure the gap between the two coupling halves is even.

Install the coupling (#49)  
Tighten the cap screws (#61)  
Torque:  
M6: 18-20Nm  
M8: 40-45Nm  
M10: 80-85Nm.  
Remove the mechanical seal spacer and rotate the coupling to check the assembly rotates freely

**18**



Install the coupling guard (#52) on the bracket (#63) and tighten the screws (#53)



**[www.whiteint.com.au](http://www.whiteint.com.au)**

**[www.whiteint.co.nz](http://www.whiteint.co.nz)**

**Please always refer to our website for further technical information & new product innovations**

**Disclaimer:** Every effort has been made to publish the correct information in this manual. No responsibility will be taken for errors, omissions or changes in product specifications.

© 2024 Copyright White International Pty Ltd

TM ® - WARNING: Please be aware that various brands & products depicted within this document are subject to trademark, patent or design registrations. Infringement of any intellectual property contained within this document without express written authority by the appropriate intellectual property holder may result in further legal action to be taken. For any queries regarding use of the contained information please feel free to contact White International Pty Ltd.